



Bauer Maschinen

Service-Katalog RB Series

Equipment and Accessories

DE | EN

N° 2





Inhalt

Content

Zubehör Kraftspülkopf Accessories Top Drive	4 - 11
Zubehör Hydraulik-Spannkopf Accessories Hydraulic Chuck Head	12
Gewindeanschlüsse Kraftspülkopf Adapter for Top Drive	13
Zieh- und Brechvorrichtungen Pull and Break-Out Devices	14
Abfangvorrichtungen Clamping Tables	15
Spannbackeneinsätze Clamping Jaw Inserts	16
Standard Bohrstrang Standard Drill String	18 - 25
Lufthebezubehör Reverse Circulation Air-Lift Accessories	26
Bedienpult RB 50 / RB 65 Control Panel	28 - 29
Kreiselpumpe Centrifugal Pump	30
Grundaustattung Bohrplatz Basic Set of Drill Site Tools	31
Service-Koffer Service Cases	32 - 37



Zubehör Kraftspülkopf – Übersicht

Accessories Top Drive – Overview

Hochdruckspülkopf (DC)
High Pressure Flushing Head



Seite | Page 6/7

Spülrohrbogen (DC/RC)
Flushing Tube



Seite | Page 9

Lufteinspeisung oben
(RC Doppelwand ID 98)
Upper Air Feed
(RC Dual-Wall ID 98)



Lufteinspeisung oben
(RC Doppelwand ID 120)
Upper Air Feed
(RC Dual-Wall ID 120)



Seite | Page 10

Spülkopf
Flushing Head

Seite | Page 8

Konstantmotor
Displacement Motor

Seite | Page 11

Option Flansch
Option Flange

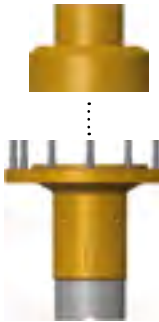

Seite | Page 13

Option Spannkopf
Option Chuck Head

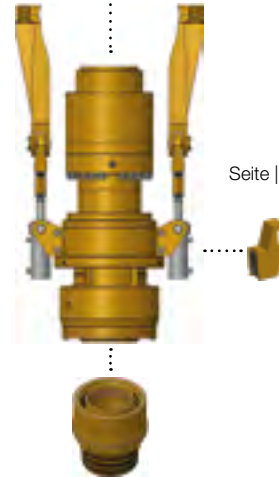

Seite | Page 12



Seite | Page 14



Zubehör Kraftspülkopf

Accessories Top Drive

Hochdruckspülkopf | High Pressure Flushing Head



Bezeichnung Description	Bauer-Best.Nr. Bauer Item No.	
	Option Spannkopf Option Chuck Head	Option Flansch Option Flange
Hochdruckspülkopf kpl. High Pressure Flushing Head cpl.	811909	843487

Bauer-Best.Nr. Bauer Item No.	Bezeichnung Description	Anzahl Quantity
1026685	Dichtsatz HD-Spülkopf High Pressure Swivel Seal Kit	1x
1026686	Reparatursatz HD-Spülkopf (inkl. Dichtsatz) High Pressure Swivel Repair Kit (incl. Seal Kit)	1x









Zubehör Kraftspülkopf

Accessories Top Drive

Hochdruckspülrohrbogen 3" | High Pressure Flushing Tube



Bauer-Best.Nr. Bauer Item No.	Bezeichnung Description
840088	Hochdruckspülrohrbogen 3" kpl. High Pressure Flushing Tube cpl.

Darstellung Illustration	Bauer-Best.Nr. Bauer Item No.	Bezeichnung Description	Anzahl Quantity
	840087	Anschlussbogen 4" Connection Bend	1x
	32426	O-Ring 94,6 x 5,33	1x
	856636	Mutterteil Weco 4" Fig 206 Female Coupling	1x
	678840	Klemmschelle Clamp	1x
	812080	Rohrschelle Pipe Clamp	1x
	812105	Lagerbock Support Trestle	1x
	725946	Oberlenker Connector	3x

Zubehör Kraftspülkopf

Accessories Top Drive

Spülkopf | Flushing Head



Bezeichnung Description	Bauer-Best.Nr. Bauer Item No.	
	S 150	L 130
Spülkopf kpl. Flushing Head cpl.	1065570	406334

Darstellung Illustration	Bezeichnung Description	Anzahl Quantity	Bauer-Best.Nr. Bauer Item No.	
			S 150	L 130
	Spülkopfpreparaturset (inkl. Dichtsatz) Flushing Head Repair Kit (incl. Seal Kit)	1x	1026399	1026499
	Spülkopfdichtsatz Flushing Head Seal Kit	1x	1026398	1026496
	Dichtbuchse Sealing Sleeve	1x	674304	406335
	Spülkopf Flushing Head	1x	674672	406334
	Quad-Ring Quad-Ring	3x	675726	720689
	V-Ring V-Ring	1x	403470	403466
	Spülkopfdichtung Flushing Head Seal	1x	505253	734304
	Abzieher Dichtbuchse Puller Sealing Sleeve	1x	788175	788174









Zubehör Kraftspülkopf

Accessories Top Drive

Spülrohrbogen | Flushing Tube



Bezeichnung Description	Bauer-Best.Nr. Bauer Item No.	
	S 150	L 130
Spülrohrbogen kpl. Flushing Tube cpl.	839844	786285

Darstellung Illustration	Bezeichnung Description	Anzahl Quantity	Bauer-Best.Nr. Bauer Item No.	
			S 150	L 130
	Flanschbogen 6" Flange Elbow	1x	684227	-
	Flanschbogen 5" Flange Elbow	1x	-	790030
	Zyl. Schraube mit I-6-kant Hexagon Socket Head Cap Screw	6x	527387	406349
	O-Ring 225 x 3	1x	402155	-
	Anschlussbogen 4" Connector Bend	1x	839843	684128
	O-Ring 154,2 x 5,7	1x	30984	
	Klemmschelle kpl. Clamp cpl.	3x	684073	
	Deckel Cover	1x	875866	
	O-Ring 65 x 3	1x	20583	
	Sechskantschraube Hexagon Screw	2x	22782	44970
	Sechskantmutter Hexagon Nut	2x	208603	201985





Zubehör Kraftspülkopf

Accessories Top Drive

Lufteinspeisung oben | Upper Air Feed





Lufteinspeisung oben 150-98/035 | Upper Air Feed

Darstellung Illustration	Bauer-Best.Nr. Bauer Item No.	Bezeichnung Description
	1355441	Lufteinspeisung oben 150-98/035 kpl. Upper Air Feed cpl.

Darstellung Illustration	Bauer-Best.Nr. Bauer Item No.	Bezeichnung Description	Anzahl Quantity
	1100585	Dichtbuchse Sealing Sleeve	1x
	505249	Axialdichtung Axial Seal	1x
	1389130	Dichtsatz Seal Kit	1x
	1389201	Reparatursatz (Inkl. Dichtsatz) Repair Kit (incl. Seal Kit)	1x

Lufteinspeisung oben 150-120/035 | Upper Air Feed

Darstellung Illustration	Bauer-Best.Nr. Bauer Item No.	Bezeichnung Description
	1359606	Lufteinspeisung oben 150-120/035 kpl. Upper Air Feed cpl.

Darstellung Illustration	Bauer-Best.Nr. Bauer Item No.	Bezeichnung Description	Anzahl Quantity
	1396324	Verschleissring Wear Ring	1x
	360396	Axialdichtung Axial Seal	1x
	1396533	Dichtsatz Seal Kit	1x
	1396476	Reparatursatz (Inkl. Dichtsatz) Repair Kit (incl. Seal Kit)	1x





Zubehör Kraftspülkopf

Accessories Top Drive

Konstantmotor | Displacement Motor



Bauer-Best.Nr. Bauer Item No.	Bezeichnung Description
663464	Konstantmotor Typ AM 160/220 Displacement Motor Typ AM 160/220

Darstellung Illustration	Bauer-Best.Nr. Bauer Item No.	Bezeichnung Description	Anzahl Quantity
	1041749	Dichtsatz Seal Kit	1x
	655267	Schaltwelle Shifter Shaft	1x
	622620	Rillenkugellager Ball Bearing	1x
	728400	Sonnenradwelle Gear Shaft	1x

Zubehör Hydraulik-Spannkopf

Accessories Hydraulic Chuck Head

Hydraulik-Spannkopf HSB 178.500 / HSB 178.300 | Hydraulic Chuck Head

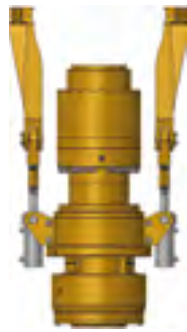

Darstellung Illustration	Bauer-Best.Nr. Bauer Item No.	Bezeichnung Description	Muffe Box	Zapfen Pin	max. kN max. kN	
	1367406	Übergang Spannkopf Crossover Sub Chuck Head	BT 65	NC	31	300
	1367401				38	
	1367402				46	
	1367403				50	
	1367404			IF	5 1/2	
	1414641			Rohling	Blank	
	1358912		TIP 178S	6 5/8	FH*90-10°	

Darstellung Illustration	Bauer-Best.Nr. Bauer Item No.	Bezeichnung Description	Ø AD (mm) Ø OD (mm)	Winkel (°) Angle (°)	Einsätze Dies	Einsatz Best.Nr. Dies Item No.
	1403434	Keil kpl. Wedge cpl.	88,9	17	1x	1403433
	1403432		101,6			1403300
	1403428		108			1403427
	1403299		114,3			1403298
	1403426		123,3			1403297
	1403425		127			1403423
	1403422		139,7			1403421
	1403382		142			1403296
	1385532		146			1385531
	1422940		152,4			1422897
	1384927		168			1384910
	1388776		177,8			1388773

Darstellung Illustration	Bauer-Best.Nr. Bauer Item No.	Bezeichnung Description
	1384909	Keil Grundkörper Clamping Wedge Body

Gewindeanschlüsse Kraftspülkopf

Adapter for Top Drive



Bezeichnung Description	Bauer-Best.Nr. Bauer Item No.		Welle Ø AD (mm) Shaft Ø OD (mm)
	S 150	L 130	
Gewindeanschluss NC 31 Drive Adapter	1373921	-	120
Gewindeanschluss NC 38 Drive Adapter	1373658	821592	
Gewindeanschluss NC 46 Drive Adapter	1373922	-	159
Gewindeanschluss NC 50 Drive Adapter	1373657	821591	
Gewindeanschluss 5 1/2 IF Drive Adapter	1373656	691726	194

Weitere Größen auf Anfrage
Other Sizes on Request



Bauer-Best.Nr. Bauer Item No.	Bezeichnung Description		Welle Ø AD (mm) Shaft Ø OD (mm)
1342840	Schiebestück 120 Sliding Sleeve		120
1342841	Schiebestück 159 Sliding Sleeve		159
1342842	Schiebestück 194 Sliding Sleeve		194

Zieh- und Brechvorrichtungen

Pull and Break-out Devices

Darstellung Illustration	Bauer-Best.Nr. Bauer Item No.	Bezeichnung Description	Muffe Größe Box Size	Muffe Typ Box Type	Rohr Ø AD Pipe Ø OD	max. KN max. KN
	1342964	Zieh- und Brechvorrichtung Pull and Break-out Device	NC38	IF	89	400
	1368026				114	
	1342965		5 1/2"		146	
	1342966				178	







Darstellung Illustration	Bauer-Best.Nr. Bauer Item No.	Bezeichnung Description	Rohr Ø AD (mm) Pipe Ø OD (mm)
	1342332	Keil 089 kpl. Wedge	89
	1342039	Keil 108 kpl. Wedge	108
	1342040	Keil 114 kpl. Wedge	114
	1342331	Keil 127 kpl. Wedge	127
	1342333	Keil 137 kpl. Wedge	137
	1342334	Keil 146 kpl. Wedge	146
	1342335	Keil 178 kpl. Wedge	178

Darstellung Illustration	Bauer-Best.Nr. Bauer Item No.	Bezeichnung Description	Anzahl Quantity
	1037320	Greifeinsatz Die Insert	2x

Abfangvorrichtungen

Clamping Tables



Darstellung Illustration	Gerät Rig	RB 20 - 30 (Ø 280)	RB 40 (Ø 457)	RB 50 (Ø 457)	RB 50 (Ø 473)	RB 50 (Ø 508)	RB 65 (Ø 508)	Anzahl Quantity	
	Bezeichnung Description	Bauer-Best.Nr. Bauer Item No.							
	Spannzylinder Clamp Cylinder	407802	1024630	1024630	791833	993048	993048	2x	
	Grundbacke Base Jaw	407799	776317	696782	820576	1005466	1005466	2x	
	Adapterbacke Adapter Jaw	N. A.	523497	696941	758592	1005583	1005583	2x	
	Steckbolzen Bolt	696851						4x	
	Steckbolzen Bolt	407846 (3x)	696880 (3x)			696880 (4x)		-	
	Spannstift Adapterbacke Spring Pin Adapter Jaw	N. A.	254865						4x
	Spannstift Grundbacke Spring Pin Base Jaw	206115	210662			528352		2x	

Spannbackeneinsätze

Clamping Jaw Inserts



Bezeichnung Description	Bauer-Best.Nr. Bauer Item No.	Rohr Ø AD (mm) Pipe Ø OD (mm)
Spannbackeneinsatz (Set) Clamping Jaw Insert (Set)	789431	88,9
	913754	101,6
	789429	108
	798069	114,3
	1340913	114,5
	1192899	127
	789430	139,7
	823181	146
	723217	158,8
	798068	168
	789428	178
	1354237	241,3
	811054	244,5
	Weitere Größen auf Anfrage Other Sizes on Request z.B. 273, 324, 339,7, 368, 419 mm	

Darstellung Illustration	Bauer-Best.Nr. Bauer Item No.	Bezeichnung Description
	1037320	Greifeinsatz Dies Insert



Generalüberholte Teile *Reconditioned Parts*

Einige unserer Ersatzteile und Komponenten sind auch als generalüberholte Variante verfügbar. Unsere hochwertige Wiederaufbereitung garantiert beste Haltbarkeit zu günstigen Konditionen.

Bei Interesse wenden Sie sich bitte an Ihren Ersatzteil-Disponenten, der Sie über Preis und Verfügbarkeit informieren wird.

Auf generalüberholte Teile gewähren wir 12 Monate Mängelhaftung.

Some of our parts and components are available as reconditioned alternative. Our high grade reconditioning process guarantees highest durability at reasonable conditions.

If we caught your interest please ask your spare parts sales manager/local service partner for price and availability.

These parts have a warranty period of 12 months.

Standard Bohrstrang

Standard Drill String

Bohrgestänge | Drill Pipes

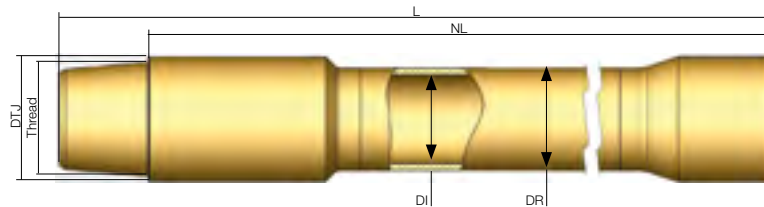

Bauer-Best.Nr. Bauer Item No.	Bezeichnung Description	Gewinde Thread	NL (mm)	Ø DR (mm)	Gewicht ca. (kg) Weight approx.	L (mm)	Ø DTJ (mm)	Ø DI (mm)
1345199	Bohrgestänge Drill Pipe	5 1/2 IF	1000	146	60	1127	177,8	126
1345200			2000		95	2127		
1345241			3000		130	3127		
1345242			6000		230	6127		
1351949			9000		330	9127		



Standard Bohrstrang Standard Drill String

Meißelübergänge | Bit Subs

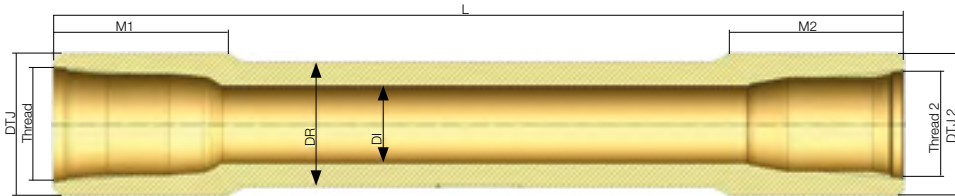

Bauer-Best.Nr. Bauer Item No.	Bezeichnung Description	Gewinde 1 Thread 1	Gewinde 2 Thread 2	L (mm)	M1 (mm)	M2 (mm)	Ø DTJ1 (mm)	Ø DTJ2 (mm)	Ø DI (mm)	Ø DR (mm)
1370505	Übergang Bit Sub	NC 38	3 1/2 REG	914,4	150	-	120,6	114,3	20,8	114,3
1370506			4 1/2 REG			150		139,7		
1370507		NC 50	3 1/2 REG	180	180	158,8	114,3	50,8	146	
1372410			4 1/2 REG			150	171,5	139,7		57,2
1370744		5 1/2 IF	6 5/8 REG	1219,2	250	250	203,2	203,2	110	178
1370750			7 5/8 REG							

Schwerstangenübergänge | Crossover Subs

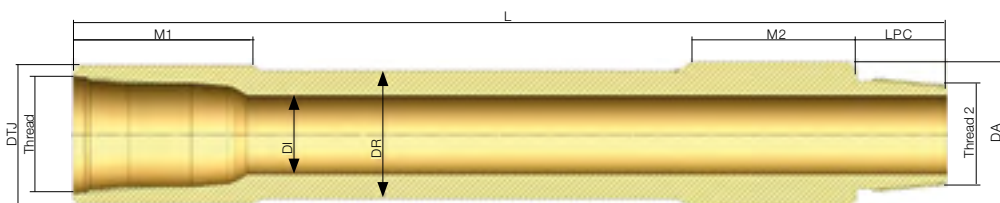

Bauer-Best.Nr. Bauer Item No.	Bezeichnung Description	Gewinde 1 Thread 1	Gewinde 2 Thread 2	L (mm)	M1 (mm)	M2 (mm)	Ø DTJ (mm)	LPC (mm)	Ø DI (mm)	Ø DR (mm)	Ø DA (mm)
1368128	Übergang Crossover Sub	NC 38	NC 50	1219,2	180	250	120,6	114,3	68,3	114,3	171,5
1380614		NC 50	5 1/2 IF		150	228,6	171,5	127	57,2	146	203,2
1370743		5 1/2 IF			250		193,7		110	178	
1380613		NC 50	180		171,5	114,3	57,2	146	171,5		

Standard Bohrstrang Standard Drill String

Schwerstangen | Drill Collars

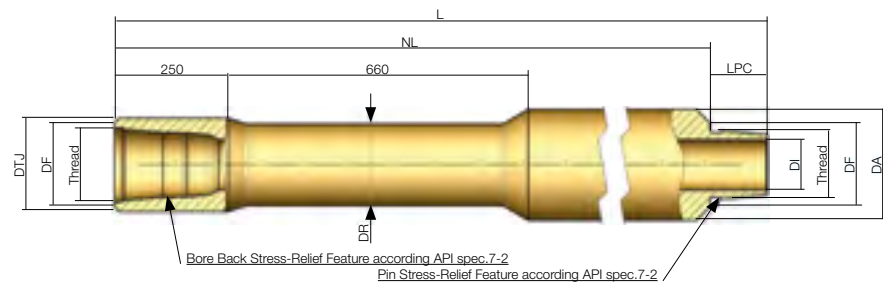

Bauer-Best.Nr. Bauer Item No.	Bezeichnung Description	NL (mm)	Ø DA (mm inch)	Gewinde Thread	Ø DTJ (mm)	LPC (mm)	Ø DF (mm)	Ø DR (mm)	Ø DI (mm)	Gewicht (kg) Weight
1348665	Schwerstange Drill Collar	6000	171,45 6 3/4	NC 50	171,5	114,3	164,7	146	88,9	760
1349246		3500	203,2	5 1/2 IF	203,2	127	181,4	178	110	590
1349247		6000	8							1040
1349243		3500	241,3 9 1/2							860
1349244		5000								1290
1349245		6000								1570



Standard Bohrstrang Standard Drill String

Stabilisatoren | Stabilizers



Bauer-Best.Nr. Bauer Item No.	Bezeichnung Description	Stabilisator Ø (mm) Stabilizer Ø (inch)	Meißel Ø (inch) Bit	Geologie Formation	Grund- körper Body	ID Ø (mm)	Rippen Anzahl Blades Quantity	Rippen Typ Blades Type	Hard- Facing			
						OD Ø (inch)						
1394889	M/Z NC 50	212,7	8 1/2	Hart Hard	88,9 6 3/4		4	gerade, integral Straight, Integral	HF 4000			
1394887	M NC 50 - M 4 1/2 REG	8 3/8		Weich Soft				gerade, geschweißt Straight, Welded	HF 1000			
1394885	M/Z NC 50	209,6		Hart Hard				110 9 1/2	3	gerade, integral Straight, Integral	HF 4000	
1394883	M NC 50 - M 4 1/2 REG	8 1/4										Weich Soft
1394948	M/Z 5 1/2 IF	308,0	12 1/4	Hart Hard	110 9 1/2	4	gerade, integral Straight, Integral	HF 4000				
1394947	M 5 1/2 IF - M 6 5/8 REG	12 1/8		Weich Soft					gerade, geschweißt Straight, Welded	HF 1000		
1394943	M/Z 5 1/2 IF	304,8		Hart Hard					110 9 1/2	3	gerade, integral Straight, Integral	HF 4000
1394941	M 5 1/2 IF - M 6 5/8 REG	12										
1394949	M/Z 5 1/2 IF	441,3	17 1/2	Hart Hard	110 9 1/2	4	gerade, integral Straight, Integral	HF 4000				
1394946	M 5 1/2 IF - M 7 5/8 REG	17 3/8		Weich Soft					gerade, geschweißt Straight, Welded	HF 1000		
1394950	M/Z 5 1/2 IF	438,2		Hart Hard					110 9 1/2	3	gerade, integral Straight, Integral	HF 4000
1394953	M 5 1/2 IF - M 7 5/8 REG	17 1/4										
1394944	M/Z 5 1/2 IF	606,4	24	Hart Hard	110 9 1/2	4	gerade, integral Straight, Integral	HF 4000				
1394884	M 5 1/2 IF - M 7 5/8 REG	23 7/8		Weich Soft					gerade, geschweißt Straight, Welded	HF 1000		
1394951	M/Z 5 1/2 IF	603,3		Hart Hard					110 9 1/2	3	gerade, integral Straight, Integral	HF 4000
1394945	M 5 1/2 IF - M 7 5/8 REG	23 3/4										

Standard Bohrstrang

Standard Drill String

Bohrmeißel | Drilling Bits

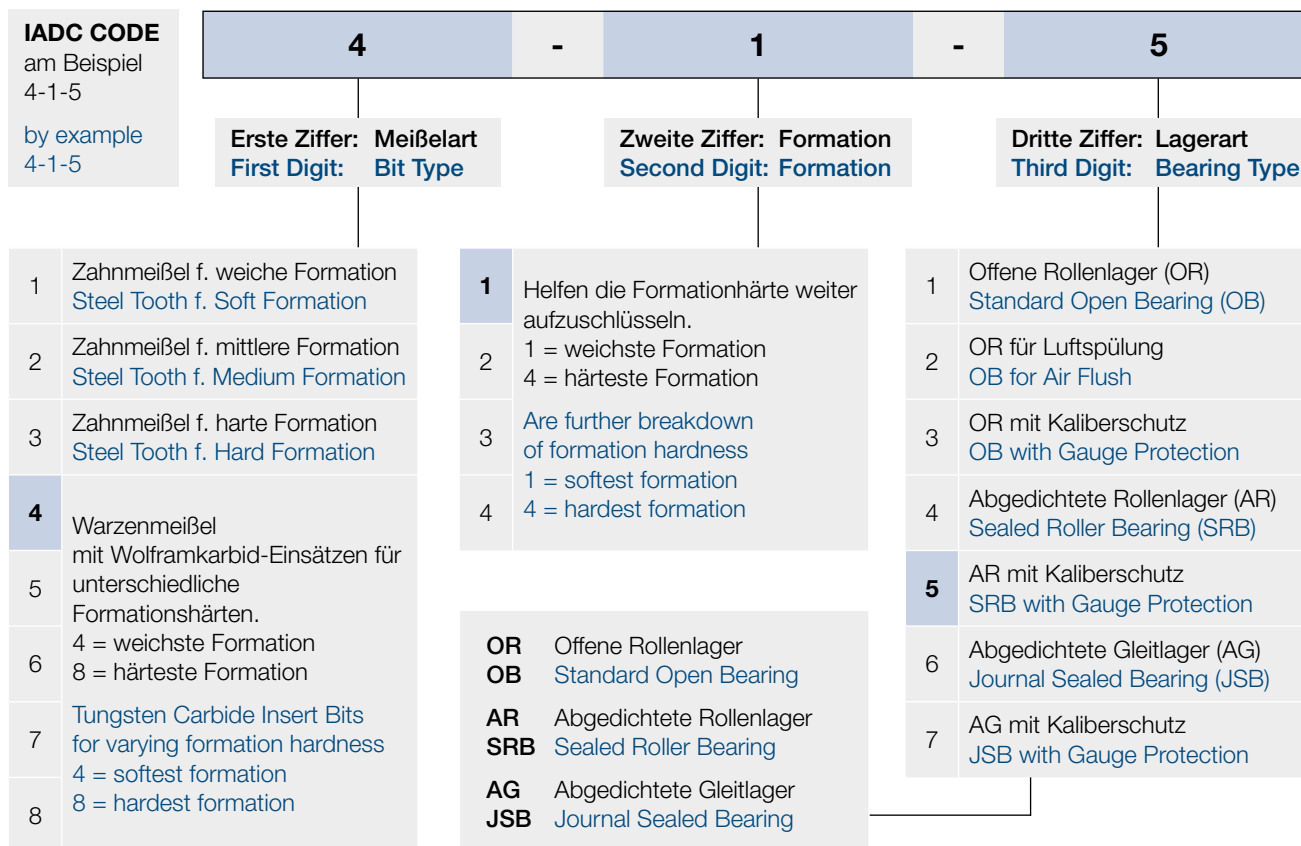

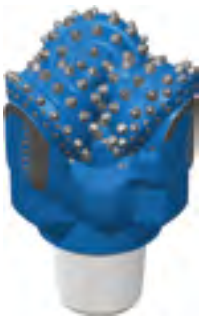
Darstellung Illustration	Bauer-Best.Nr. Bauer Item No.	Bezeichnung Description	IADC-Code	Gewinde Thread	Zentrumsbohrung Center Hole (mm)
	758897	Dreikegelrollenmeißel 8 1/2" Tricone	2-1-1	4 1/2 REG	70
	1208007		4-1-5		
	758896		5-3-5		
	758895	Dreikegelrollenmeißel 12 1/4" Tricone	6 5/8 REG	2-1-1	100
	1208006			4-1-5	
	917125			5-3-5	
	758893	Dreikegelrollenmeißel 17 1/2" Tricone	7 5/8 REG	2-1-1	100
	1208005			4-1-5	
	758892			5-3-5	
982590	Dreikegelrollenmeißel 24" Tricone	2-1-1			

Standard Bohrstrang Standard Drill String

Schlüsseltopf | Bit Breaker



Bauer-Best.Nr. Bauer Item No.	Bezeichnung (inch) Description (inch)	Innendurchmesser (inch) Inner Diameter (inch)	Spannzapfen (mm) Clamping Pin (mm)
1055437	Schlüsseltopf Ø -12 1/4 Bit Breaker Ø -12 1/4	13 1/4	146
1055281	Schlüsseltopf Ø -24 Bit Breaker Ø -24	25	146



Standard Bohrstrang Standard Drill String

Rotary-Zangen | Manual Tongs



Bezeichnung Description	Bauer-Best.Nr. Bauer Item No.	
	B / HT55	C / HT35
Rotary-Zangen Manual Tongs	728521	728520

Darstellung Illustration	Bezeichnung Description	Größe Size (inch)	Bauer-Best.Nr. Bauer Item No.	
			B / HT55	C / HT35
	Einsatzbacken Lug Laws	3 1/2 - 5	666545	-
		3 1/2 - 5 1/4	-	726129
		5 - 6 3/4	665570	-
		6 5/8 - 9	665569	-
		7 - 8 5/8	-	665516
		9 - 10 3/4	665568	-
		9 5/8 - 10 3/4	-	665517
		13 3/8	665544	-

Standard Bohrstrang Standard Drill String

Hebezapfen | Lifting Plug Pin









Darstellung Illustration	Bauer-Best.Nr. Bauer Item No.	Bezeichnung Description	Gewinde Thread	Tragkraft (kN) Load Rating
	1395063	Hebezapfen Lifting Plug Pin	NC 38	50
	1395062		NC 50	
	1395067		5 1/2 IF	
	1395532		NC 26	
	1395467		NC 31	
	1395468		NC 46	
	1395469		6 5/8 REG	
	1395470		7 5/8 REG	
	1395482		DWG 219	

Hebemuffen | Lifting Plug Box

Darstellung Illustration	Bauer-Best.Nr. Bauer Item No.	Bezeichnung Description	Gewinde Thread	Tragkraft (kN) Load Rating
	1395064	Hebemuffe Lifting Plug Box	3 1/2 REG	50
	1395010		4 1/2 REG	
	1070803		6 5/8 REG	
	1070804		7 5/8 REG	
	1070805		8 5/8 REG	100

Lufthebezubehör für S 150

Reverse Circulation Air-Lift Accessories for S 150

Darstellung Illustration	Bauer-Best.Nr. Bauer Item No.	Bezeichnung Description
	812303	Lufthebeausrüstung S 150 ohne Spannkopf Airlift Equipment S 150 without Chuck Head
	955598	Lufthebeausrüstung S 150 mit Spannkopf Airlift Equipment S 150 with Chuck Head
	1129823	Lufthebegestänge Startersatz Airlift Start Kit
	1343263	Lufthebegestänge 1" 500 (Pupjoint) Airlift Pipe
	1343264	Lufthebegestänge 1" 3500 Airlift Pipe
	981373	Lufthebegestänge 1" 6000 Airlift Pipe
	791045	Hebezapfen 1" LH, Tragkraft 15 kN Lifting Plug Pin AL, Load Rating 15 kN
	790029	Anschlussbogen 6" Connector Bend
	775732	Austragsschlauch Set 6" Discharge Hose Kit
	1470243	Aufhängung Austragsschlauch Support Discharge Hose
	1343824	Prallkasten Pacifier Box



myBAUER

The Service Platform on the Internet



Was ist myBAUER?

- 24/7 Kundenportal
- Online-Ersatzteilkatalog
- Flottenmanagement
- Warenkorb
- Informationsstelle
- Anbindung von WEB-BGM und vieles mehr



Vorteile für Sie:

- Sie bestellen ganz einfach über unseren Online-Ersatzteilkatalog – weltweit und rund um die Uhr
- Wir stellen Ihnen Ihre Gerätestücklisten und -dokumentationen online zur Verfügung
- Sie sparen Zeit bei der Suche nach passenden Ersatz- und Serviceteilen
- Wir archivieren Ihre Bestellungen und Sie können diese als Kopiervorlage wiederverwenden

What is myBAUER?

- *24/7 customer portal*
- *Online spare parts catalogue*
- *Fleet management*
- *Shopping cart*
- *Information source*
- *connection to WEB-BGM and much more*





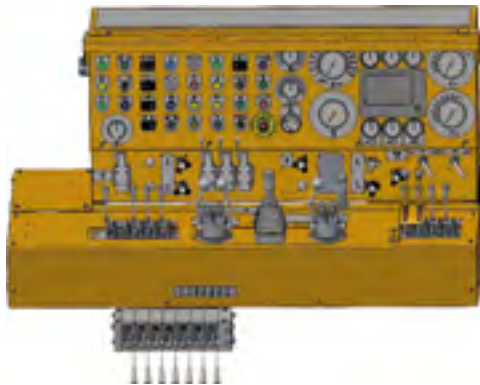

Benefits for you

- *Order easily via Internet – worldwide and 24/7*
- *You have online access to your parts lists and technical documentations at any time*
- *You save time searching for the required spare parts and wear and tear parts*
- *Your orders are recorded to be reused in full or in parts of it*

Bedienpult RB 50

Control Panel RB 50









Darstellung Illustration	Bauer-Best.Nr. Bauer Item No.	Bezeichnung Description	Anzahl Quantity
-	1099568	Umbausatz AT 98 auf MCQ 4000 Conversion Kit AT 98 to MCQ4000	1x
	1197968	MCQ 4000	1x
	432916	Vorsteuerventil KSK Kippen / Heben / Senken Pilot Valve KSK Tilt / Raise / Lower	1x
	846293	Vorsteuerventil KSK Drehen / Heben / Senken Pilot Valve KSK Turn / Raise / Lower	1x
	410877	Hebel E-Taster zu 846293 Button Lever for 846293	1x
	767206	Vorsteuerventil Kompressor / Pumpe / PTO Pilot Valve Compressor / Pump / PTO	1x
	777787	Wegeventil 4/2 Valve	4x

Bedienpult RB 65

Control Panel RB 65









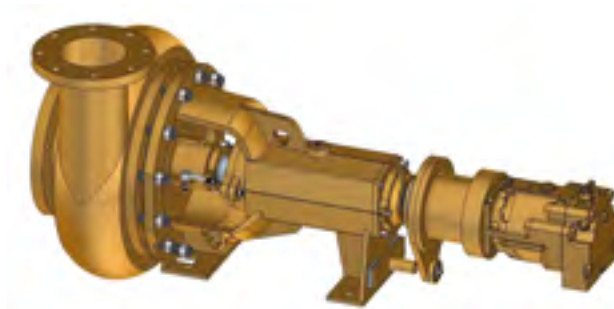

Darstellung Illustration	Bauer-Best.Nr. Bauer Item No.	Bezeichnung Description	Anzahl Quantity
	1197968	Fahrzeugterminal 10 in Monitor 10 in	2x
	974420	Drehgeber Rotating Transmitter	1x
	991188	Joystick analog Joystick Analog	8x
	1127418	Joystick Ausleger Hilfswinde Joystick Boom Auxiliary Winch	1x
	989747	Joystick Vorschub / Winde Joystick Feed Device / Winch	1x
	989748	Joystick KSK Joystick Top Drive	1x

Kreiselpumpe

Centrifugal Pump









Bezeichnung Description	Bauer-Best.Nr. Bauer Item No.	
	Mission Magnum	Mission Sandmaster
Kreiselpumpe kpl. Centrifugal Pump cpl.	764988	1402055

Darstellung Illustration	Bezeichnung Description	Anzahl Quantity	Bauer-Best.Nr. Bauer Item No.	
			Mission Magnum	Mission Sandmaster
	Gehäuse bearbeitet Casing finished	1x	776222	776222
	Dichtung Gehäuse Seal for Casing	1x	654099	654099
	LaufRad 13" Impeller 13"	1x	718934	718934
	Dichtung LaufRad Seal for Impeller	1x	720617	720617
	Antriebswelle Drive Shaft	1x	637525	1465679
	Passfeder für Antriebswelle Feather Key for Drive Shaft	1x	637527	637527
	Gleitringdichtung Mechanical Seal	1x	653976	653976
	Stopfbuchspackung Packing, Shaft	1x	740886	-

Grundausrüstung Bohrplatz

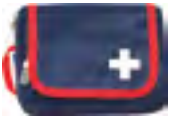
Basic Set of Drill Site Tools

Darstellung Illustration	Bauer-Best.Nr. Bauer Item No.	Bezeichnung Description
	1092114	Gewindefett Kopr-Kote 20 kg Thread Grease
	1394881	Gewindebürste Thread Brush
	734306	Spülungstestkoffer Mud Test Case
-	882636	Filterpapier Filter Paper
	873706	Kabellichtlot 200 m Water Level Meter
	784382	Tiefenlot 200 m Depth Meter
	853789	Erste Hilfe Set First Aid Kit
	279644	Feuerlöscher Fire Extinguisher













Elektrik Steckverbindersortiment

Electric Pin and Socket Connection























* Die Werte in Klammern sind die im Koffer enthaltenen Stückzahlen.
 * Alle Komponenten sind auch einzeln erhältlich.
 * The values in brackets are the numbers of items included in the case
 * All components are also available separately.

Bauer-ID: 734978

Darstellung Illustration	Bauer-Best. Nr. Bauer Item No.	Darstellung Illustration	Bauer-Best. Nr. Bauer Item No.	Darstellung Illustration	Bauer-Best. Nr. Bauer Item No.
	Bezeichnung Description		Bezeichnung Description		Bezeichnung Description
	356598 (10x) Steckergehäuse mit Endkappe 2-polig Plug Case 2 pole		370481 (8x) Steckergehäuse mit Endkappe 3-polig Plug Case 3 pole		370495 (5x) Dose 4-polig Socket 4 pole
	360556 (5x) Dose 6-polig Socket 6 pole		381838 (2x) Steckergehäuse mit Endkappe 8-polig Plug Case 8 pole		381839 (2x) Steckergehäuse mit Endkappe 12-polig Plug Case 12 pole
	356599 (10x) Stecker 2-polig Plug 2 pole Keil Wedge		370492 (8x) Stecker 3-polig Plug 3 pole Keil Wedge		370496 (5x) Dose 4-polig Socket 4 pole Keil Wedge
	360558 (5x) Dose 6-polig Socket 6 pole Keil Wedge		381923 (2x) Stecker 8-polig Plug 8 pole Keil Wedge		381924 (2x) Stecker 12-polig Plug 12 pole Keil Wedge

Elektrik Steckverbindersortiment

Electric Pin and Socket Connection

Darstellung Illustration	Bauer-Best. Nr. Bauer Item No.	Darstellung Illustration	Bauer-Best. Nr. Bauer Item No.	Darstellung Illustration	Bauer-Best. Nr. Bauer Item No.
	Bezeichnung Description		Bezeichnung Description		Bezeichnung Description
	356595 (10x)		370479 (8x)		370493 (5x)
	Stecker mit Endkappe 2-polig Plug with End Cap 2 pole		Stecker mit Endkappe 3-polig Plug with End Cap 3 pole		Stecker 4-polig Plug 4 pole
	360555 (5x)		381835 (2x)		381837 (2x)
	Stecker 6-polig Plug 6 pole		Stecker 8-polig Plug 8 pole		Stecker 12-polig Plug 12 pole
	356596 (10x)		370480 (8x)		370494 (5x)
	Stecker 2-polig Plug 2 pole Keil Wedge		Stecker 3-polig Plug 3 pole Keil Wedge		Stecker 4-polig Plug 4 pole Keil Wedge
	360557 (5x)		381840 (2x)		381841 (2x)
	Stecker 6-polig Plug 6 pole Keil Wedge		Stecker 8-polig Plug 8 pole Keil Wedge		Stecker 12-polig Plug 12 pole Keil Wedge
	370497 (100x)		370498 (100x)		505209 (1x)
	Stiftkontakt 1 mm ² Contact Pin		Buchsenkontakt 1 mm ² Bushing Contact		Auspin Werkzeug Kontakte Demounting Tool Contacts
	356600 (100x)		356597 (100x)		505208 (1x)
	Stiftkontakt 1,5 mm ² Contact Pin		Buchsenkontakt 1,5 mm ² Bushing Contact		Auspin Werkzeug Kontakte Demounting Tool Contacts
	356601 (1x)		735455 (1x)		427154 (50x)
	Universal Press- zange Kontakte Contact Plier		Auspin Werkzeug Kontakte Demounting Tool Contacts		Dichtstecker weiß Plug White



Zentralschmierung



Central Lubrication



- * Die Werte in Klammern sind die im Koffer enthaltenen Stückzahlen.
- * Alle Komponenten sind auch einzeln erhältlich.
- * The values in brackets are the numbers of items included in the case.
- * All components are also available separately.









Bauer-ID: 766249

Darstellung Illustration	Bauer-Best. Nr. Bauer Item No.
	Bezeichnung Description
	767794 (10 m)
	Hochdruckschlauch High Pressure Hose
	390983 (10x)
	Rohrstutzen gerade, steckbar Tube Stub Straight, Plug-in
	416501 (20x)
	Kniestück 90°, M 10 x 1 Connector

Darstellung Illustration	Bauer-Best. Nr. Bauer Item No.
	Bezeichnung Description
	767793 (10 m)
	Plastikrohr Plastic Tubing
	425950 (5x)
	Rohrstutzen gerade, schraubbar Tube Stub Straight, Screw-in
	416502 (10x)
	Kniestück 90°, M 8 x 1 Connector

Zentralschmierung

Central Lubrication

Darstellung Illustration	Bauer-Best. Nr. Bauer Item No.	Darstellung Illustration	Bauer-Best. Nr. Bauer Item No.
	Bezeichnung Description		Bezeichnung Description
	<p>390954 (15x)</p> <p>Schwenkverschraubung M 10 x 1 Connector, Banjo</p>		<p>409651 (15x)</p> <p>Rohrverbinder Tube-to-Tube Connector</p>
	<p>390987 (10x)</p> <p>Hülse Sleeve</p>		<p>390889 (15x)</p> <p>Adapter M 10 x 1 Adapter</p>
	<p>765897 (10x)</p> <p>Kniestück 90°, M 10 x 1 Connector</p>		<p>766248 (10x)</p> <p>Adapter M 8 x 1 Adapter</p>
	<p>634717 (15x)</p> <p>Verbinder M 8 x 1 Connector</p>		<p>390942 (15x)</p> <p>Verbinder M 10 x 1 Connector</p>

Messen/Analyse Hydraulisch

Measure/Analysis Hydraulic







- * Die Werte in Klammern sind die im Koffer enthaltenen Stückzahlen.
- * Alle Komponenten sind auch einzeln erhältlich.
- * The values in brackets are the numbers of items included in the case
- * All components are also available separately.

Bauer-ID: 734656

Darstellung Illustration	Bauer-Best. Nr. Bauer Item No.	Bezeichnung Description
	11673	(4x) Überwurfmutter M 18 x 1,5 - 12 L Box Nut
	11676	(2x) Überwurfmutter M 22 x 1,5 - 15 L Box Nut
	240538	(4x) Überwurfmutter M 16 x 1,5 - 8 S Box Nut
	21489	(4x) Verschraubung 12 L Screwing
	36680	(2x) Verschraubung 15 L Screwing
	30469	(4x) Verschraubung 8 S Screwing
	235546	(4x) Verschlusskegel 12 S/L Locking Cone
	235538	(2x) Verschlusskegel 15 L Locking Cone
	235539	(4x) Verschlusskegel 8 S/L Locking Cone
		34956
27557		(2x) Minimessanschluss 15 L Minimeter Connection
20023		(4x) Minimessanschluss 8 S Minimeter Connection
22068		(2x) Minimessanschluss 1/4" Minimeter Connection
27552		(2x) Minimessanschluss 1/2" Minimeter Connection
25062		(2x) Minimessanschluss 3/8" Minimeter Connection
34951		(2x) Minimessanschluss 12 x 1,5 Minimeter Connection
27556		(2x) Minimessanschluss 14 x 1,5 Minimeter Connection

Messen/Analyse Hydraulisch

Measure/Analysis Hydraulic

Darstellung Illustration	Bauer-Best. Nr. Bauer Item No.	Bezeichnung Description
	230817	(4x) L-Stutzen 8 S L-Fitting
	230820	(4x) L-Stutzen 12 L L-Fitting
	230823	(3x) L-Stutzen 15 L L-Fitting
	230837	(4x) T-Stutzen 8 S T-Fitting
	230840	(4x) T-Stutzen 12 L T-Fitting
	230843	(3x) T-Stutzen 15 L T-Fitting
	966545	(1x) Digital Manometer G 1/4" Manometer Digital
	459111	(1x) Gummischutz für Manometer Digital Rubber Cover for Manometer Digital
	27573	(1x) Minimessanschluss Minimeter Connection inkl. Dichtkantenring incl. Edged Sealing Ring
	48048	(1x) Manometeranschluss-Schlauch 1000 mm Manometer Connection Hose
	22978	(1x) Manometeranschluss-Schlauch 2500 mm Manometer Connection Hose
	76552	(1x) Manometeranschluss-Schlauch 5000 mm Manometer Connection Hose





International Service Hotline

We follow the sun

+800 1000 1200*

+49 8252 97-2888
BMA-Service@bauer.de

*toll-free number, where available

Um eine schnelle Hilfe zu gewährleisten, stehen Ihnen englischsprachige und temporär auch deutschsprachige Ansprechpartner zur Verfügung. Wir bieten Ihnen technischen Support sowie Ersatzteillieferungen bei Maschinenstillstand in Notfällen, auch außerhalb der Geschäftszeiten. Ausfallkosten und Baustellenstillstände lassen sich somit erheblich reduzieren.

To ensure quick assistance, there are English speaking and temporarily German speaking contact partners available. We offer technical support and spare parts delivery during machine breakdown in urgent cases, subject to processing fee. Breakdown costs and stand stills at the sites can herewith be reduced significantly.

24/7





BAUER Maschinen GmbH
BAUER-Strasse 1
86529 Schrobenhausen
Germany
Phone: +49 8252 97-0
bma-parts-and-service@bauer.de
www.bauer.de

Die Materialien und Spezifikationen können ohne vorherige Ankündigung geändert werden. Die Abbildungen enthalten möglicherweise optionale Ausstattungen und zeigen nicht alle möglichen Konfigurationen. Diese Angaben und die technischen Daten dienen als Anhaltspunkte. Irrtümer und Druckfehler sind vorbehalten.

Materials and specifications are subject to change without notice. Illustrations may include optional equipment and not show all possible configurations. These and the technical data are provided as indicative information only, with any errors and misprints reserved.